

**B traject**  
Totaal 6400m

- 1km voor H1
- 2km na H2
- 3km voor H4
- 4km na H5
- 5km voor H6
- 6km na H6

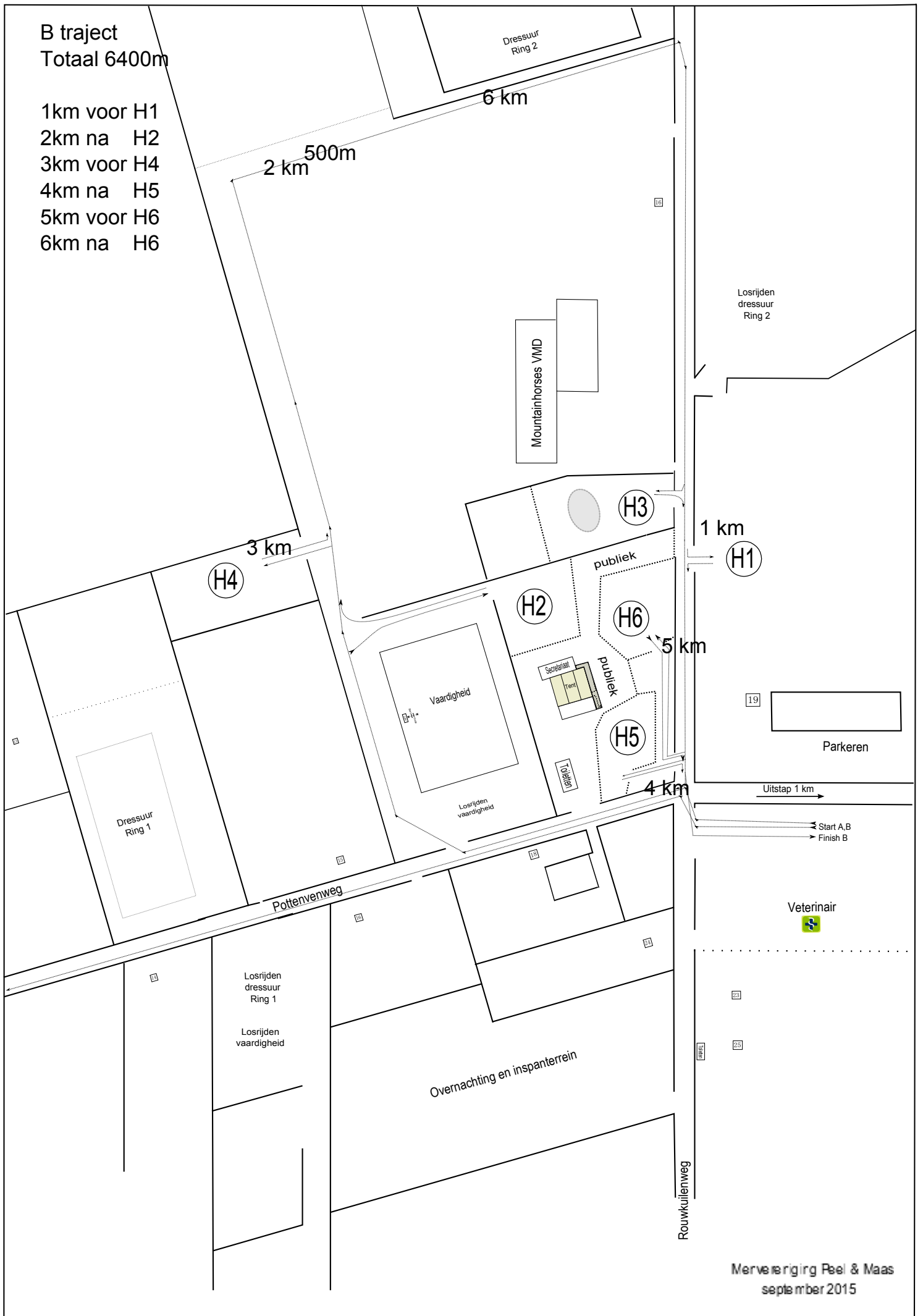

⊗ afrijdbaar element

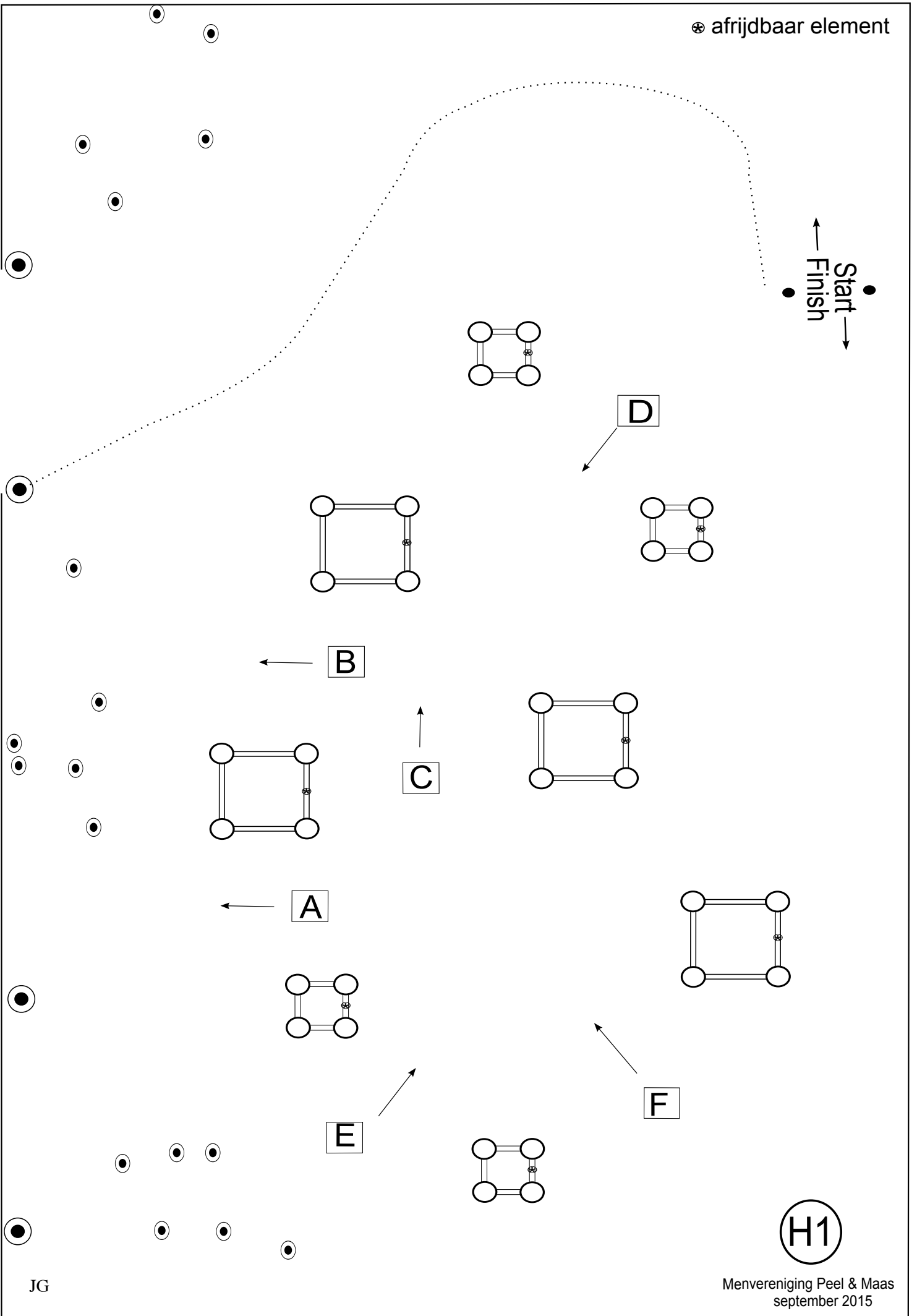

Start →  
← Finish

B

C

A

E

D

F

H1

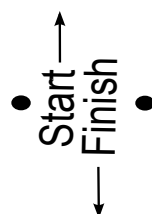
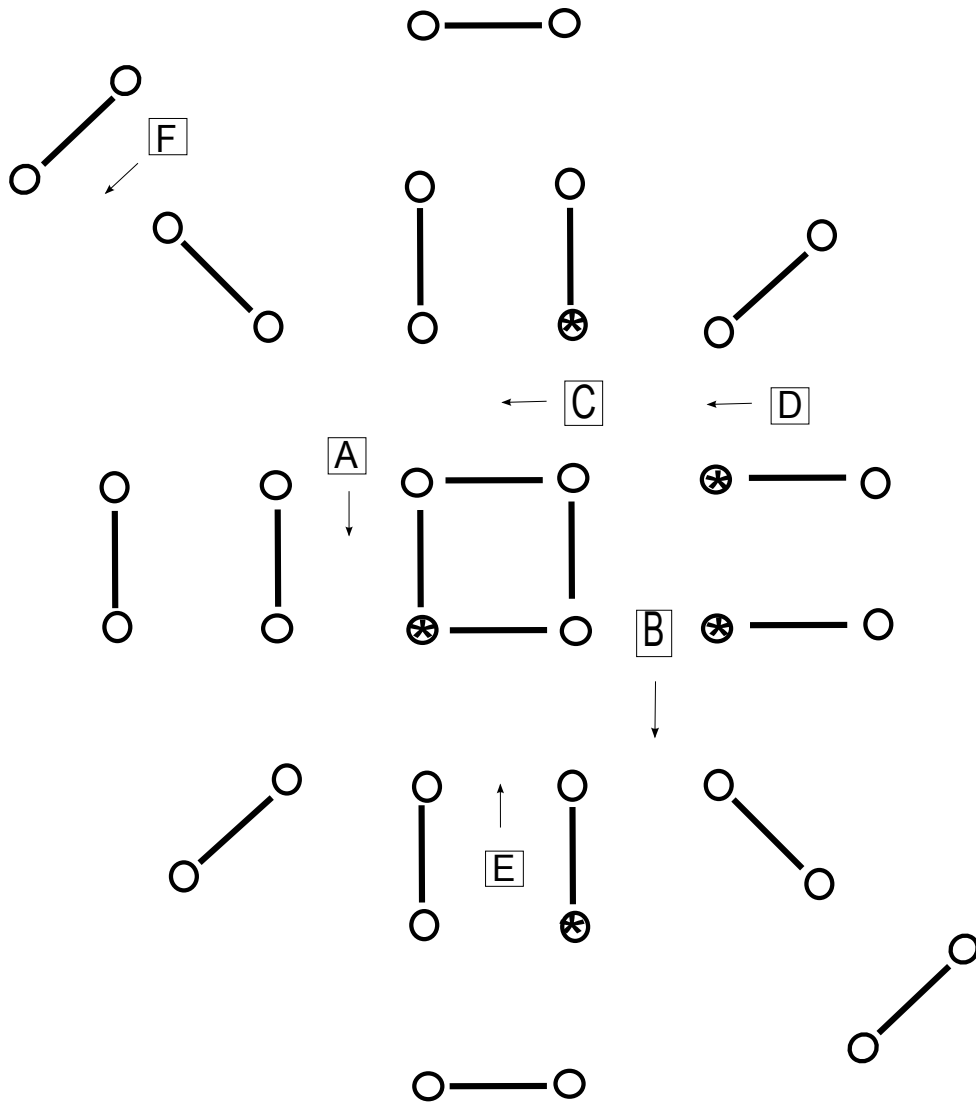

in uit  
↓ ↑

⊗ afrijdbaar element

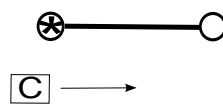
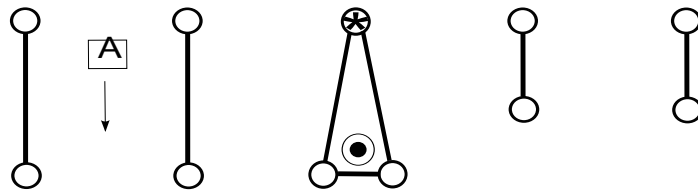
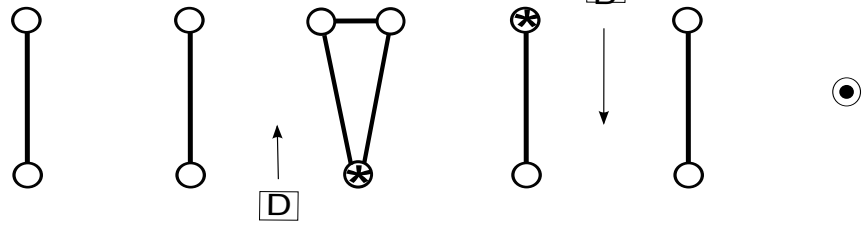
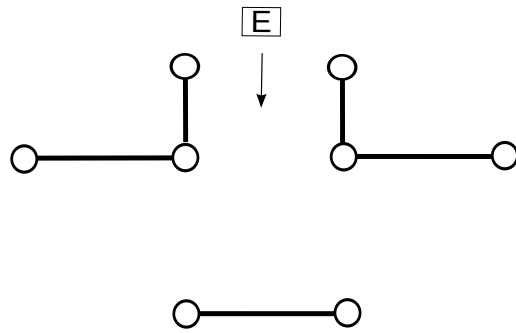

Start →  
← Finish

